

D Gearbox

Worm Gearbox

W Type

Worm Solid Type Gearbox

Dimensions

Model: 8WD□BL/BR/BRL

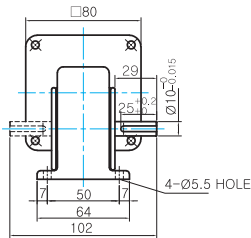
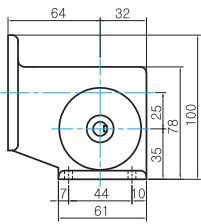

KEY SPEC

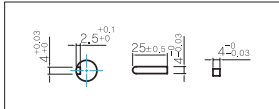

WEIGHT

Model	WEIGHT(Kg)
8WD□BL/BR/BRL	0,67

8WD□BL/□BR/□BRL Max. Permissible Torque

* These are reference figures when the Gearbox is attached to the induction motor.

Motor Output	Gear Ratio		10	12	15	18	25	30	36	50	60
	60Hz	50Hz	r/min								
15W	60Hz	50Hz	180	150	120	100	72	60	50	36	30
			150	125	100	83	60	50	42	30	25
	15W	60Hz	kgfcm								
			9.8	11.5	13.9	16.0	21.0	23.8	27.6	36.0	39.6
	25W	60Hz	11.5	13.4	16.2	18.6	24.5	27.7	32.3	42.0	46.2
			14.8	17.3	20.8	24.0	31.5	35.6	41.5	54.0	59.4
25W	50Hz	18.0	21.1	25.4	29.3	38.5	43.6	50.7	66.0	72.6	

- 1) Enter the gear ratio in the box (□) within the Gearbox model name.
- 2) The rotating speed is calculated by dividing the motor's synchronous speed (50Hz: 1,500r/min, 60Hz: 1,800r/min) by the gear ratio. The actual speed is 2~20% less than the displayed value, depending on the size of the load.
- 3) Calculation of N.m \approx kgfcm X 0.98

Dimensions

Model: 9WD□BL/BR/BRL

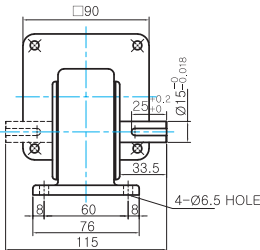
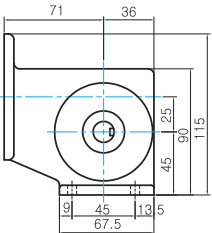

KEY SPEC

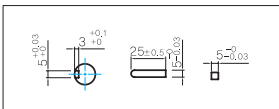

WEIGHT

Model	WEIGHT(Kg)
9WD□BL/BR/BRL	1,0

9WD□BL/□BR/□BRL Max. Permissible Torque

* These are reference figures when the Gearbox is attached to the induction motor.

Motor Output	Gear Ratio		10	12	15	18	25	30	36	50	60
	60Hz	50Hz	r/min								
40W	60Hz	50Hz	180	150	120	100	72	60	50	36	30
			150	125	100	83	60	50	42	30	25
	40W	60Hz	kgfcm								
			23.0	26.9	32.3	37.3	49.0	55.4	64.5	84.0	92.4
	60W	60Hz	27.9	32.6	39.3	45.3	59.5	67.3	78.3	102.0	112.2
			34.4	40.3	48.5	55.9	73.5	83.2	96.8	126.0	122.4
60W	50Hz	42.6	49.9	60.1	69.3	91.0	103.0	119.8	142.9	122.4	
		55.8	65.3	78.5	90.6	119.0	134.6	153.1	142.9	122.4	
90W	50Hz	60.7	71.0	85.5	98.6	129.5	146.5	153.1	142.9	122.4	
		62.3	73.0	87.8	101.2	133.0	150.5	153.1	142.9	122.4	
120W	60Hz	80.4	94.1	113.2	130.5	142.9	163.3	153.1	142.9	122.4	

- 1) Enter the gear ratio in the box (□) within the Gearbox model name.
- 2) The rotating speed is calculated by dividing the motor's synchronous speed (50Hz: 1,500r/min, 60Hz: 1,800r/min) by the gear ratio. The actual speed is 2~20% less than the displayed value, depending on the size of the load.
- 3) Calculation of N.m \approx kgfcm X 0.98

Gearbox Images



WH Type Worm Hollow Type Gearbox

Dimensions

● Model: 9WHD□-030

● FLANGE

● SHAFT(Unidirectional, Bi-directional)

● KEY SPEC

● WEIGHT

Model	WEIGHT(Kg)
9WHD□-030	1,13

* The output flange and shafts are sold separately.

9WHD□-030 – Max. Permissible Torque

* These are reference figures when the Gearbox is attached to the induction motor.

Motor Output	Gear Ratio		7.5	10	15	20	25	30	40	50	60	80
	60Hz	r/min	240	180	120	90	72	60	45	36	30	22
	50Hz		200	150	100	75	60	50	38	30	25	18
60W	60Hz	kgfcm	26.5	34.0	47.9	60.5	69.3	80.6	99.1	113.4	126.0	132.7
	50Hz		32.8	42.1	59.3	74.9	85.8	99.8	122.7	140.4	156.0	132.7
90W	60Hz		42.8	55.1	77.5	97.9	112.2	130.6	160.5	173.5	163.3	132.7
	50Hz		46.6	59.9	84.4	106.6	122.1	142.1	174.6	173.5	163.3	132.7
120W	60Hz		47.9	61.6	86.6	109.4	125.4	145.9	179.4	173.5	163.3	132.7
	50Hz		61.7	79.4	111.7	141.1	161.7	188.2	183.7	173.5	163.3	132.7
150W	60Hz		61.1	78.6	110.6	139.7	160.1	186.2	183.7	173.5	163.3	132.7
	50Hz		71.2	91.5	128.8	162.7	186.5	204.1	183.7	173.5	163.3	132.7
180W	60Hz		69.3	89.1	125.4	158.4	181.5	204.1	183.7	173.5	163.3	132.7
	50Hz		88.2	113.4	159.6	183.7	214.3	204.1	183.7	173.5	163.3	132.7
200W	60Hz		81.9	105.3	148.2	183.7	214.3	204.1	183.7	173.5	163.3	132.7
	50Hz		94.5	121.5	171.0	183.7	214.3	204.1	183.7	173.5	163.3	132.7

- 1) Enter the gear ratio in the box (□) within the Gearbox model name.
- 2) The rotating speed is calculated by dividing the motor's synchronous speed (50Hz: 1,500r/min, 60Hz: 1,800r/min) by the gear ratio. The actual speed is 2~20% less than the displayed value, depending on the size of the load.
- 3) Calculation of N.m = kgfcm X 0.98

Gearbox Image

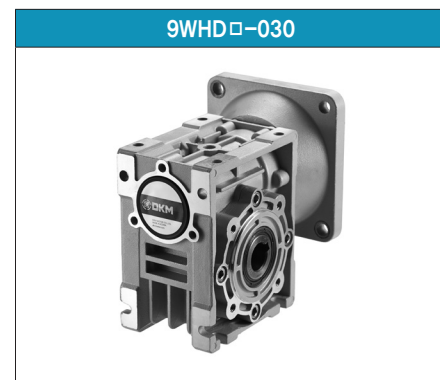

D Gearbox

Worm Gearbox

WH Type Worm Hollow Type Gearbox

Dimensions

● Model: 9WHD□-040

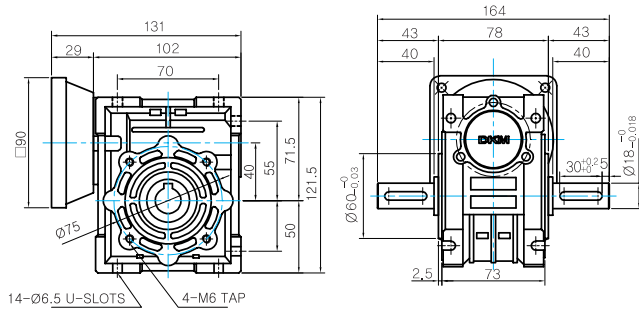

14-Ø6.5 U-SLOTS 4-M6 TAP

● FLANGE

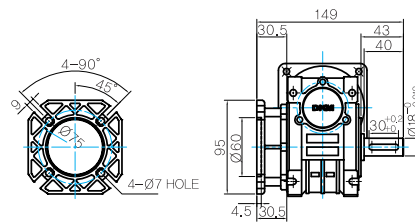

● SHAFT(Unidirectional, Bi-directional)

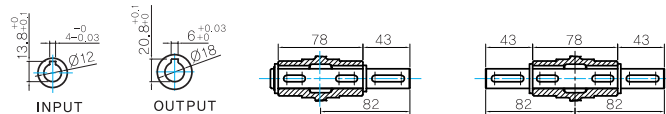

INPUT OUTPUT

● KEY SPEC

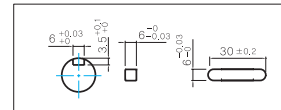

● WEIGHT

Model	WEIGHT(Kg)
9WHD□-040	1,13

* The output flange and shafts are sold separately.

● Model: 10WHD□-040

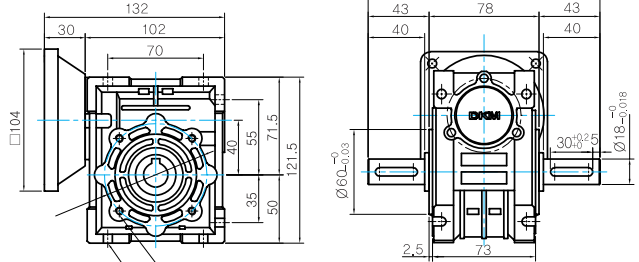

14-Ø6.5 U-SLOTS 4-M6 TAP

● SHAFT(Unidirectional, Bi-directional)

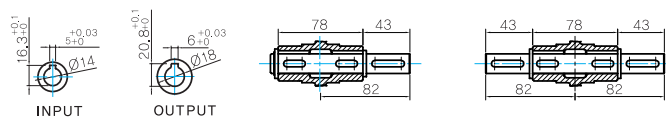

INPUT OUTPUT

● FLANGE

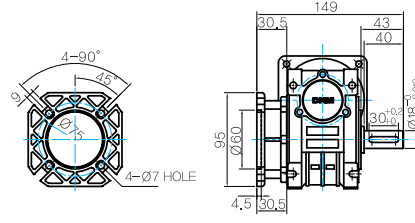

● KEY SPEC

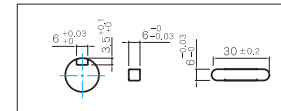

● WEIGHT

Model	WEIGHT(Kg)
10WHD□-040	2,2

* The output flange and shafts are sold separately.

10WHD□ - 040 – Max. Permissible Torque

* These are reference figures when the Gearbox is attached to the induction motor.

Motor Output	Gear Ratio	7.5	10	15	20	25	30	40	50	60	80	100
250W	60Hz	200	150	100	75	60	50	37.5	30	25	18.75	15
	50Hz	240	180	120	90	72	60	45	36	30	22.5	18
300W	60Hz	kgfcm	100	130	190	240	290	325	305	-	-	-
	50Hz	N.m	9.80	12.70	18.60	23.50	28.40	31.80	29.90	-	-	-
300W	60Hz	kgfcm	115	150	215	275	335	375	350	-	-	-
	50Hz	N.m	11.20	14.70	21.00	26.90	32.80	36.70	34.30	-	-	-
300W	60Hz	kgfcm	95	125	175	225	270	300	285	-	-	-
	50Hz	N.m	9.30	12.20	17.10	22.00	26.40	29.40	27.90	-	-	-
400W	60Hz	kgfcm	125	160	230	295	355	395	375	-	-	-
	50Hz	N.m	12.20	15.60	22.50	28.90	34.80	38.70	36.70	-	-	-

1) Enter the gear ratio in the box (□) within the Gearbox model name.

2) The rotating speed is calculated by dividing the motor's synchronous speed (50Hz: 1,500r/min, 60Hz: 1,800r/min) by the gear ratio. The actual speed is 2~20% less than the displayed value, depending on the size of the load.

3) Calculation of N.m = kgfcm X 0.98

Gearbox Image

